

The original: made in Germany since 1951



Inventor of
Roller Skates

Moving heavy loads

on Roller Skates Express
and Heavy Duty Wheels

easily and safely
worldwide

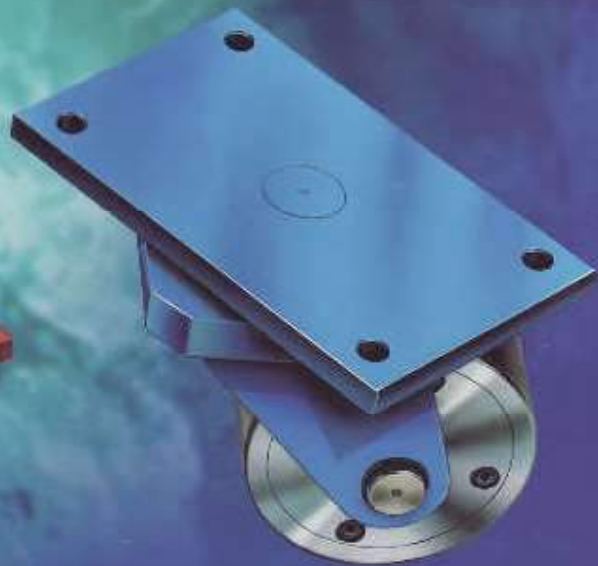
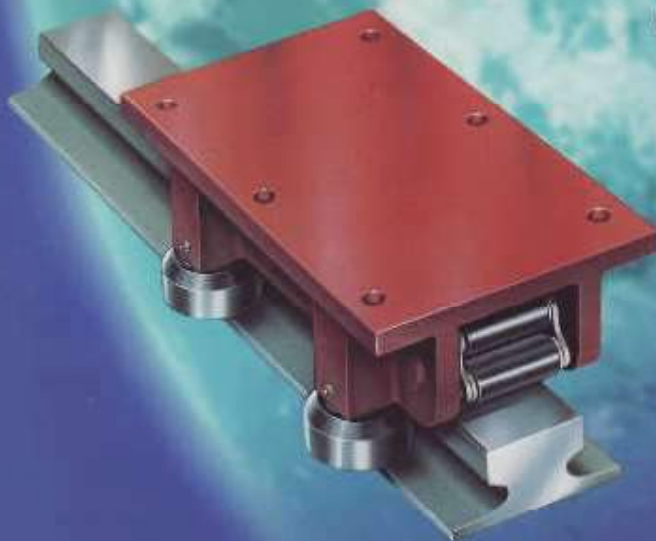

Moving heavy loads easily and safely with ROLLER SKATE EXPRESS – one of the smallest transport devices with the highest carrying capacity available.

The idea

We started with the idea of placing the rear roller automatically in front whilst using 3 rollers or bars to advance the load. This reduces the danger of accidents and ensures easier, continuous transportation. From this idea we developed our industrial skate for moving heavy loads:

Roller Skate Express

Advantages

The advantages of using Roller Skate Express are self-evident:

- solid construction guarantees long product life with minimum maintenance.
- low level construction of Roller Skate (between 7 and 20 cm) reduces the danger of tilting and requires minimum raising of the load whilst placing the Roller Skate underneath.
- little effort required to overcome rolling resistance within the chain assembly (approximately 3% of total load under ideal conditions and using a larger diameter of roller).
- a variety of applications for very different conditions. Several decades (more than 50 years) of experience in numerous applications.
 - at sea, on, under and in the sea, and offshore)
 - on land (bridge-building and relocation of bridges or bridge-parts, moving of complete spectators' stand, of complete blast furnace, of big machinery, parts of nuclear reactors, as a machine-part in tube production machines, in tunnelling (Métro of Paris, Montblanc tunnel, channel Eurotunnel)
- versatile universal transportation device.
- very economic basic unit.

Products

Increased demands and the requests for specialised Roller Skates for new application, called for the development of a wide variety of different models:

- different versions for different applications:
 - the Solids for the variable short-term use
 - the Robusts for projects involving short moves
 - the Super-Robusts for permanent loads, short or long distances
- different models for different carrying capacities:
 - the Solids: 5 standard-models with single capacities from 10 to 80 metric tons
 - the Robusts: 6 standard-models with single capacities from 15 to 85 metric tons
 - the Super-Robusts: 18 standard-models with single capacities from 15 to 400 metric tons

Special designs are part of our normal business: with over 2500 different applications to date.

Conditions for safe and successful Applications

The following principles help to ensure the successful use of Roller Skates:

- Only a good strong surface will ensure the smooth running of this transportation process; additional strengthening may be required e.g. by using steel plates of at least 10 mm thickness. All our capacities are based on a steel surface, which withstands the high floor pressure of the Roller Skate Express.
- The larger the diameter of the roller in the chain, the easier it is to move the load, and less stress is placed on the steel track surface.
- Select fewer Roller Skates with larger diameter rollers, rather than more Roller Skates with smaller diameter rollers.
- Roller Skate Express is to be placed exactly parallel to the direction of movement.
- The load must be spread evenly over the carrying rollers and have equal contact with the track surface.

Maintenance

- If the Roller Skate is treated as a normal tool, no particular maintenance is necessary. The Roller Skate has a very long life.
- To prolong this long life cycle, we recommend cleaning the Roller Skate with a thin machine cleaner.
- In exceptional cases, please contact us for advice.
- If the Roller Skate Express does not serve its purpose in transporting heavy loads because:
 - the speed is insufficient
 - the floor pressure is too high
 - the rolling resistance is too high

find out more about

Heavy Duty Wheels In part 2 of the catalogue.

For variable transportation

Roller Skate - The Robusts - Complete Transport Kit

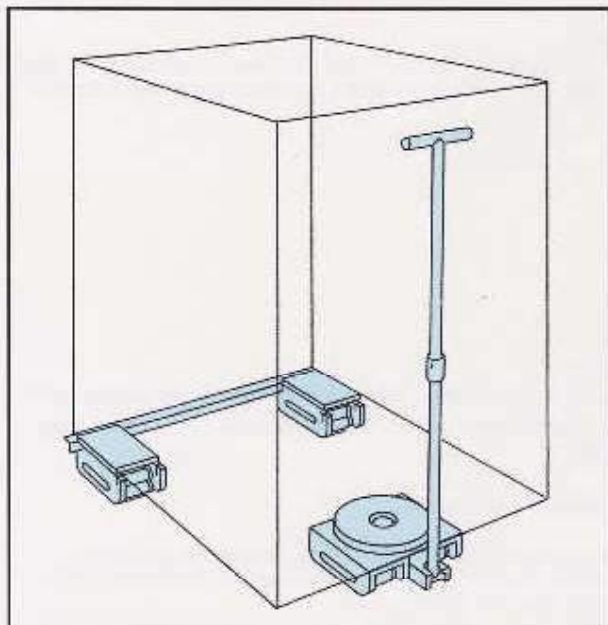

Range of application:

- With the Hercules you do not have to waste time in assembling the unit, and the low level contributes to safer working conditions.
- The Hercules makes it easier and safer to move heavy loads. 24 and 30 mm diameter rollers in the chain are available. This turntable is larger than the one in the Transport Kit N.
- For larger loads we recommend the use of a second twin Skate Roller with turntable in the front, and two normal skates as stabilisers at the back.

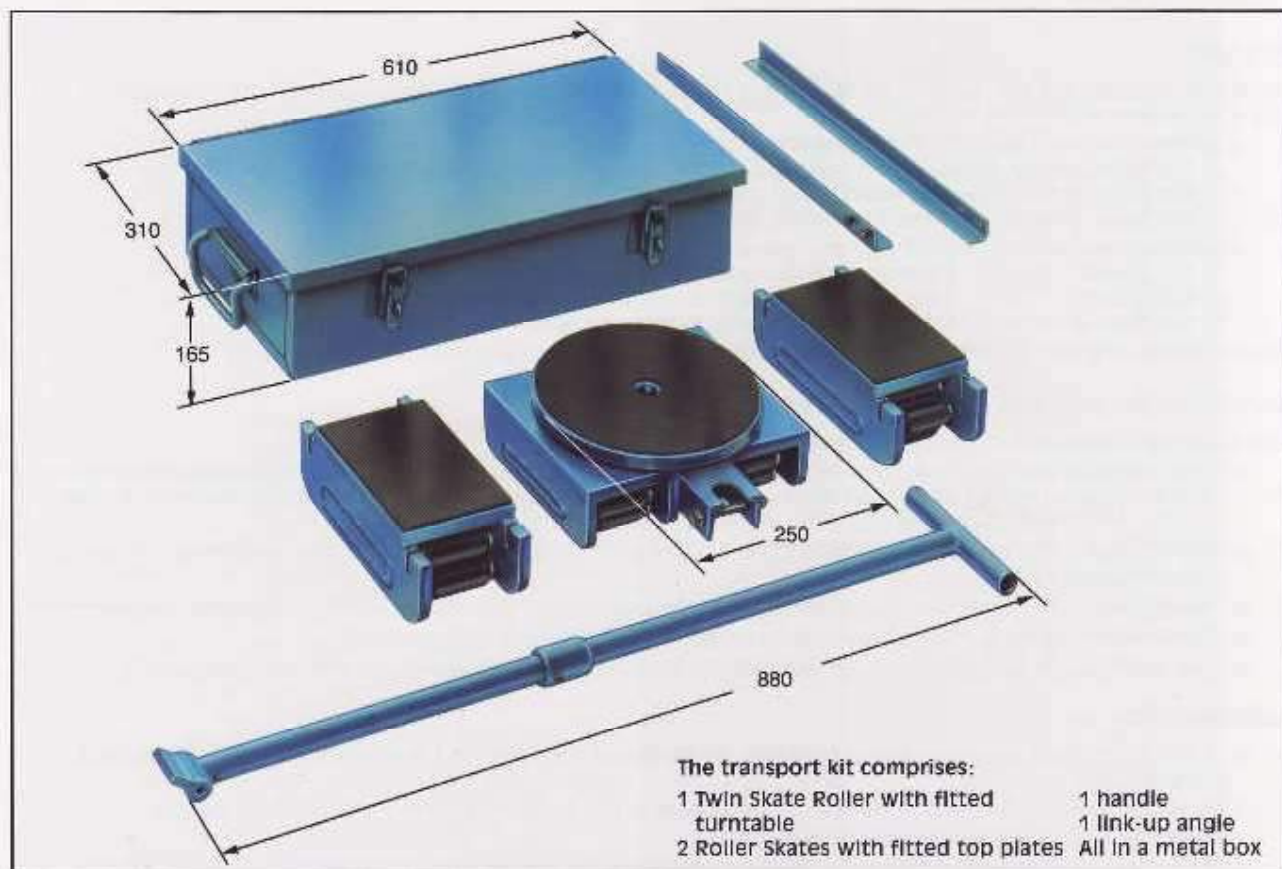

Mod. Hercules

Mod.	Rollers Ø Twin	Rollers Ø Single	Length support	Width support	Total height	Swivel-pl. Ø	Max. load kN	Weight of set		
Hercules	30	24	200	130	110	250	350	68		

All dimensions in mm

Roller Skate – The Solids – Complete Transport Kit

Range of application:

- For short, variable transportation distances.
- Movement of moderately heavy loads, e.g. machines, parts of machines and for installation works,
- A speed of 5 m/min should not be exceeded.
- It is possible to turn corners by placing turntables on top of the Roller Skates. Handles have to be attached but only guide the load while the Roller Skates are moving.
- Minimum turning circle is 3 m.

Hints on use:

- All maximum carrying capacities are based for use on a steel surface, which withstands the pressure of the chain-roller. For safety, the carrying capacities in complete sets are calculated so that 2 Roller Skates could support the full load on uneven surfaces.
- The track surface is important for the safe transportation of the load, not the carrying capacity of the Roller Skate.
Tiles are unsuitable. Movement on tarmac and concrete is restricted. In these cases it is recommended to put a steel plate of a minimum of 10 mm thickness underneath.



- Possible problems can be avoided by choosing Roller Skate models with larger diameter rollers in the chain.
- Visual control for the alignment and direction of the load is made easier by inserting the angle iron into the slots provided on the Roller Skate.
- The difference in height of Skates with turntables is compensated by the use of packing plates.



The complete set consists of:
 4 Roller Skates Mod. N 2 Handles
 2 Turntables 2 link-up bars
 2 packing plates 1 metal box

Complete transport kit Mod. N

Mod.	Rollers Ø	Length support	Width support	Total height	Swivel-pl. Ø	Max. load kN	Weight of set			
I	18	120	120	108	130	200	48			
II	24	120	120	117	130	300	56			
III	30	130	130	140	150	600	90			

All dimensions in mm

Accessory only for models ... N

For variable transportation

Roller Skate Express – The Solids



Swivel/Turntable

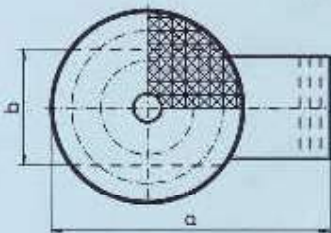
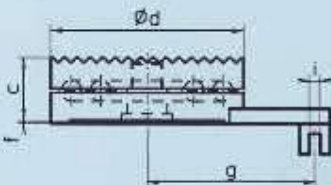
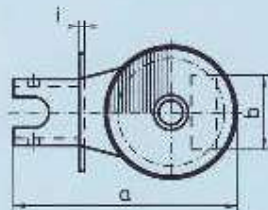
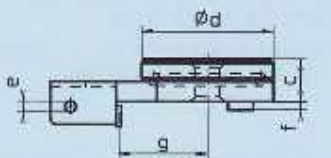

Mod. I-III

Mod. IV-V

Packing plate / Levelling plate

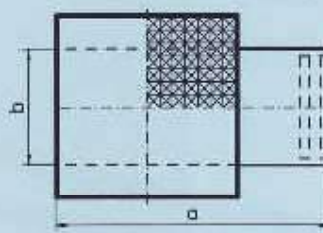
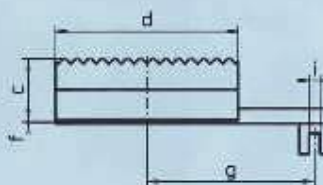
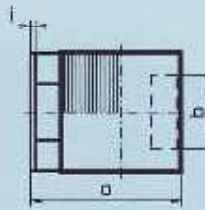
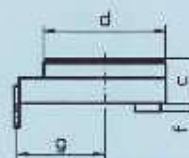

Necessary for turning corners: Turntables are to be placed on top, handle has to be attached; only guide while Roller Skate is moving. Minimum turning circle is 3 m.

Necessary for use with turntable: packing plate for compensating the difference in height between Skates with turntables and the ones without.

Turntable

Packing plate / Levelling plate

Mod.	a	b	c	Ø d	e	f	g	l	Weight kg	Mod.	a	b	c	d	f	g	l	Weight kg
I	220	73	42	130	11	8	87	5	4.5	I	149	73	42	120	8	87	5	3.7
II	220	86	42	130	11	8	87	5	4.5	II	149	86	42	120	8	87	5	3.7
III	250	96	48	150	11	8	108	5	6.7	III	178	96	48	130	8	108	5	5.3
IV	275	114	61	190		3	165	11	13.7	IV	270	114	61	180	3	165	11	13.8
V	360	128	61	220		3	235	11	18.9	V	350	128	61	200	3	235	11	18.8

All dimensions in mm

Roller Skate Express – The Solids

Range of application:

- For short variable ways of transportation.
- Movement of moderately heavy loads, e.g. machines, parts of machines and for installation works.
- A speed of 5 m/min should not be exceeded.
- Allows to turn corners by swivelling. Turntables are placed on top of the skate, handles are to be attached. Only guide with the handle, while the Roller Skate is moving. Minimum turning circle is 3 m.
- The difference in height of skates with the turntables is compensated for by the use of packing plates.
- Easy visual control for the alignment and direction of the load is made by inserting the angle iron into the slots provided on the Roller Skate.

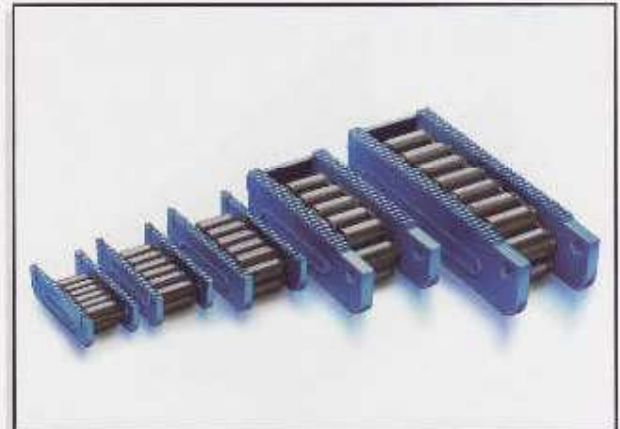

Characteristics of the most sold series Express model... N:

- stable, solid, basic construction
- low level construction
- Accessories for turning corners

Hints on use:

- The track surface is important for the safe transportation of the load, not the carrying capacity of the Roller Skate. Tiles are insufficient. The movement on tarmac and concrete is restricted. In these cases a steel plate of a minimum of 10 mm thickness is recommended.

- Possible problems can be avoided by choosing Roller Skate models with a larger roller diameter within the chain.
- All maximum carrying capacities are based for use on a steel surface, which withstands the high pressure of the chain-rollers. For safety, the carrying capacities on complete sets are calculated so that on uneven surfaces 2 Roller Skates could support the full load.
- Due to the little effort required to overcome the rolling resistance (4-7 % of the total load) precautionary measures must be taken for use on inclined surfaces.

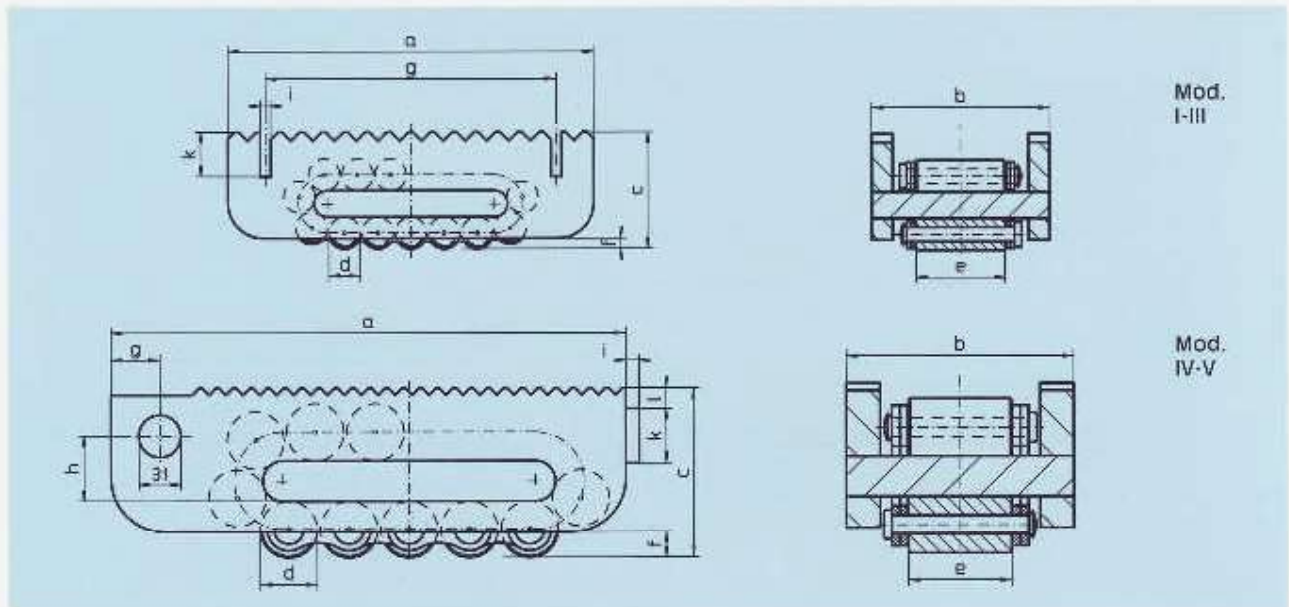

Mod. N

Mod.	a	b	c	Ø d	e	f	g	h	i	k	l	Rollers under stress	Number of rollers	Max. load kN	Weight kg
I	210	100	66	18	51	6	167		6	25		5	15	100	5.2
II	220	113	75	24	60	10	180		6	25		4	13	150	7.3
III	270	130	92	30	68	10	217		6	25		4	13	300	13.0
IV	380	168	127	42	76	16	36	48	10	40	15	4	13	600	32.0
V	530	182	147	50	86	19	36	60	10	40	15	6	17	800	61.0

All dimensions in mm

For simple transportation

Roller Skate Express – The Solids



Hints on use:

- If the Rollers are being used to their maximum carrying capacity or with lengthy intervals between use choose models with a hardened centre plate (= model C-H).
- In case of possible overload, choose chain roller material 50CrV4 (B.S. 735 A 50; SAE 6150) (= models C-H-50CrV4).
- Maximum speed: 5 m/min.
- The rolling resistance depends on the track.
For smaller models I-III 7-5 %, for larger models 5-3 % of the total load.
- If necessary this model can be reduced in height for special applications.
- For scaffolding application the chain alone can be used. (length according to customers' specification).

Range of application:

- For short distances.
- If possible on suitable tracks, e.g. crane rails or steel beams.
- Movement of moderately heavy loads e.g. to transport materials in ovens, for shuttering, concreting or stocking techniques.
- Use as a conveyor, when the load is moving and the Roller Skates are fixed.
- Ideal model for confined spaces.

Characteristics of the Series of model... C:

- Stable, solid basic construction.
- Low level construction and smooth top achieved after welding, models C and B are of the same height.
- Can be welded to the load to ensure Roller Skates and load are firmly connected.
- Available with hardened centre plate (= models C-H) or additionally with higher tensile roller material 50CrV4 (= SAE 6150) (= models C-H-50CrV4).

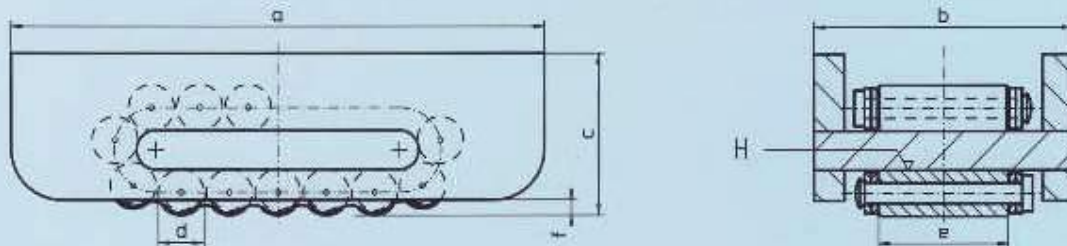

Mod. C, C-H (H = hardened and machined centre plate), C-H-50CrV4 (roller material 50CrV4)

Mod.	a	b	c	Ø d	e	f					Rollers under stress	Number of Rollers	Maximum load kN	Weight kg
I	210	100	63	18	51	6					5	15	100	5.0
II	220	113	73	24	60	10					4	13	150	7.0
III	270	130	90	30	68	10					4	13	300	12.5
IV	380	168	126	42	76	19					4	13	600	32.0
V	530	182	146	50	86	19					6	17	800	61.0

All dimensions in mm